

mind the gap

## HIGH-TECH- FLOOR JOINT PROFILES

FOR MULTI-STOREY AND  
BASEMENT CAR PARKS

- ◆ metal free, therefore cannot corrode
- ◆ tight coating connection
- ◆ water tight
- ◆ low installation height
- ◆ individual colour design

FloorBridge® 

# VISIBLE AND COATABLE ADVANTAGES

FloorBridge® profiles – the solution for floor joints

**Floor joints are a major challenge in every building and, especially in multi-storey and basement car parks, they are exposed to severe loadings.**

Large car park areas are exposed to weather, water, aggressive salts and mechanical stress for very long periods. Particularly problematic is the transition area between a floor joint profile and the car park coating. Our floor joint profiles in carbon fibre composite technology – specially developed for these areas of application – combine many technical advantages compared with conventional profiles.

Since the weather together with de-icing salts is also carried directly from the outside into multi-storey and basement car parks, the water tightness and the metal-free properties of the FloorBridge® joint system become an essential criteria for a smoothly running, maintenance-free and permanent operation.

Resulting from a similar co-efficient of thermal expansion between our joint profile and bordering car park coatings and thanks to the unique recessed connection flange, a water tight and force-fitted transition to the car park coating is ensured.

Owing to its metal-free properties and its high chemical resistance the FloorBridge® joint profiles are, of course, non-corrosive and resistant against frost and de-icing salts.

Another key feature is the low installation height and the simplicity of installation, which makes the FloorBridge® joint profile ready to take traffic after only a few hours.

Traditional metal solutions are frequently reaching their limits when it comes to corrosion protection or complicated joint courses and connections.

A novelty is the possibility to coat the FloorBridge® joint profile in the same color design as the car park coating.



- Metal-free, therefore cannot corrode
- Water-tight application possible
- Low installation height
- Simple installation
- Temperature resistant and weatherproof
- Tight coating connection
- Partial, quick repair possible
- Thermal expansion co-efficient similar to car park coating
- Replaceable expansion insert without damaging the car park coating (CPS-Profile)
- Perfect coating connection due to the recessed connection flange
- A special rapid implementation can be drives on after a few hours
- Hardly noticeable vibrations under direct car traffic
- Stock item, therefore short delivery times



You don't have to look for to see the benefits as they speak for themselves!

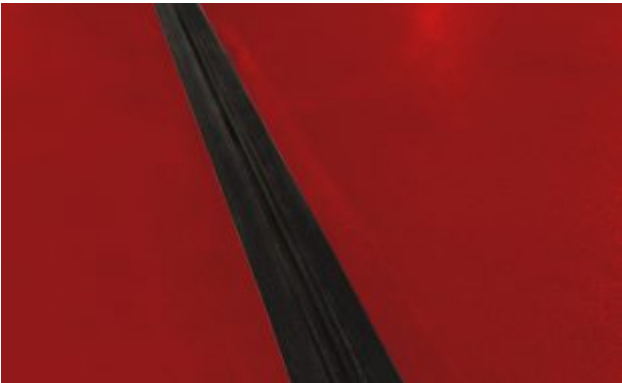



# FloorBridge® CPS 20/50

FloorBridge® joint profile with replaceable expansion insert

## DESCRIPTION OF THE JOINT PROFILE

The FloorBridge® joint profile CPS 20/50 is a pre-fabricated polymer floor joint profile in carbon fibre composite technology with or without coating flange and replaceable expansion insert. The FloorBridge® joint profile CPS 20/50 produces hardly noticeable vibration, when trafficked. It is suitable for vertical and horizontal joint movements. The FloorBridge® joint profile CPS 20/50 can be supplied with or without a coating flange, depending on requirements. A watertight connection in the transition area to the coating, concrete or asphalt can be achieved.

## AREA OF APPLICATION

Joint profile for new construction and for the renovation of floor joints in multi-storey and basement car parks, park decks, shopping malls and ramps.

## FEATURES / BENEFITS

- metal-free – therefore cannot corrode
- tight coating connection
- replaceable expansion insert without damaging the car park coating
- suitable for vertical and horizontal movements of the joint
- simple installation
- low installation height
- temperature resistant, weatherproof and chloride resistant
- suitable for vehicular traffic
- can be driven on after a few hours

## VERSIONS

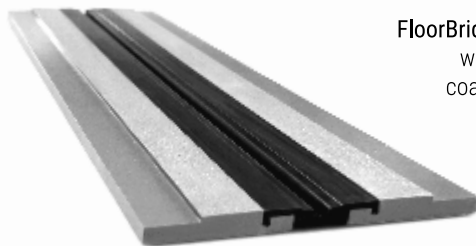

FloorBridge® CPS 20/50  
with double-sided  
coating connection

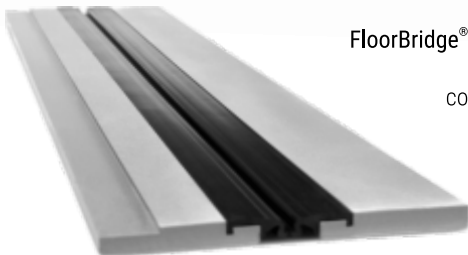

FloorBridge® CPS 20/50 DUO  
with one-sided  
coating connection

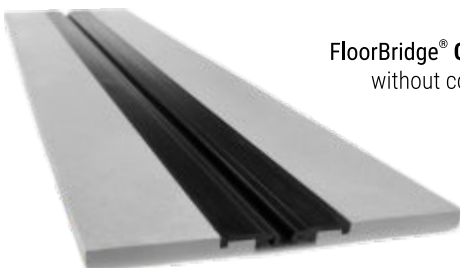

FloorBridge® CPS 20/50 MONO  
without coating connection

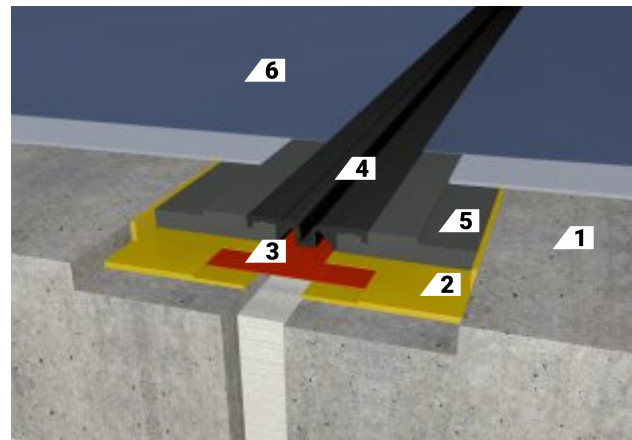

- 1 concrete
- 2 composite adhesive
- 3 sealing tape
- 4 replaceable expansion insert
- 5 joint profile CPS 20/50
- 6 coating

## TECHNISCHE DATEN

Width of joint profile:	ca. 290 mm
Length of joint profile:	ca. 1200 mm installed (1195 mm net)
Thickness of joint profile:	ca. 23 mm
Joint width in the substrate:	max. 50 mm
Total horizontal joint movement:	50 mm (-20/+30 mm)
Total vertical joint movement:	30 mm (-15/+15 mm)
Compressive strength:	60 N/mm <sup>2</sup> (ONR 23303)
Load (Truck):	600 kN (DIN 1072)

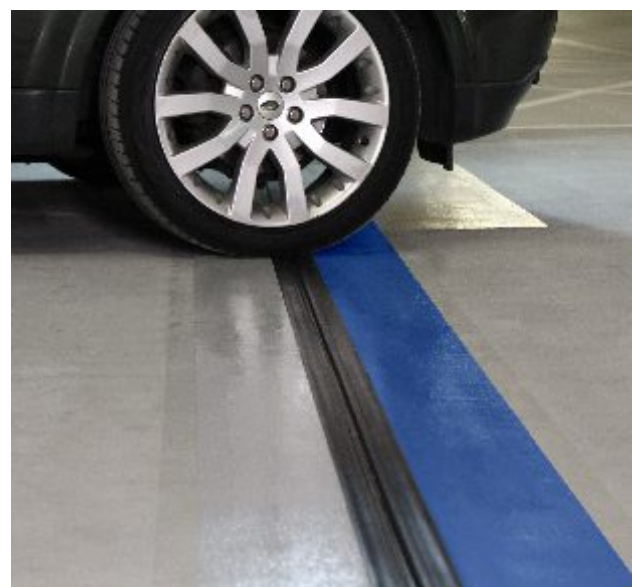

# FloorBridge® CPS 20/80

FloorBridge® joint profile with replaceable expansion insert

## DESCRIPTION OF THE JOINT PROFILE

The FloorBridge® joint profile CPS 20/80 is a pre-fabricated polymer floor joint profile in carbon fibre composite technology with or without coating flange and replaceable expansion insert. The FloorBridge® joint profile CPS 20/80 produces hardly noticeable vibration, when trafficked. It is suitable for vertical and horizontal joint movements. The FloorBridge® joint profile CPS 20/80 can be supplied with or without a coating flange, depending on requirements. A watertight connection in the transition area to the coating, concrete or asphalt can be achieved.

## AREA OF APPLICATION

Joint profile for new construction and for the renovation of floor joints in multi-storey and basement car parks, park decks, shopping malls and ramps.

## FEATURES / BENEFITS

- metal-free – therefore cannot corrode
- tight coating connection
- replaceable expansion insert without damaging the car park coating
- suitable for vertical and horizontal movements of the joint
- simple installation
- low installation height
- temperature resistant, weatherproof and chloride resistant
- suitable for vehicular traffic
- can be driven on after a few hours

## VERSIONS

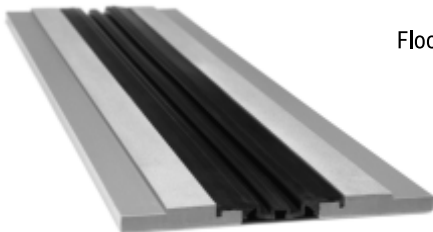

FloorBridge® CPS 20/80  
with double-sided  
coating connection

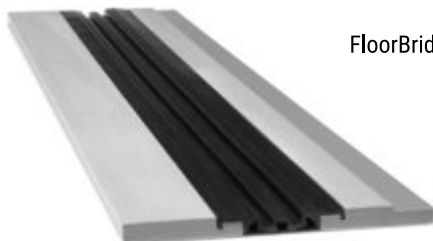

FloorBridge® CPS 20/80 DUO  
with one-sided  
coating connection

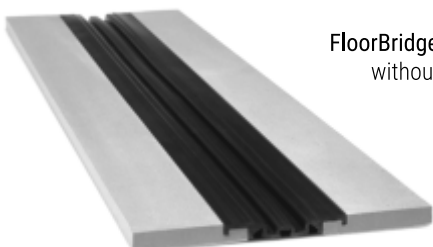

FloorBridge® CPS 20/80 MONO  
without coating connection

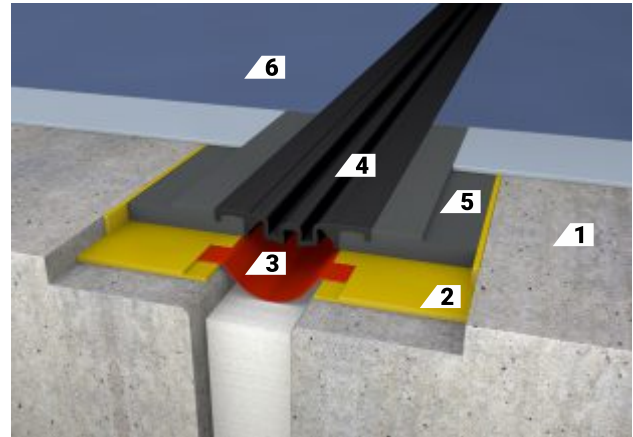

- |                           |                                |
|---------------------------|--------------------------------|
| 1 concrete                | 2 composite adhesive           |
| 3 sealing tape            | 4 replaceable expansion insert |
| 5 joint profile CPS 20/80 | 6 coating                      |

## TECHNISCHE DATEN

Width of joint profile:	ca. 325 mm
Length of joint profile:	ca. 1200 mm installed (1195 mm net)
Thickness of joint profile:	ca. 23 mm
Joint width in the substrate:	max. 80 mm
Total horizontal joint movement:	80 mm (-30/+50 mm)
Total vertical joint movement:	50 mm (-25/+25 mm)
Compressive strength:	60 N/mm <sup>2</sup> (ONR 23303)
Load (Truck):	600 kN (DIN 1072)

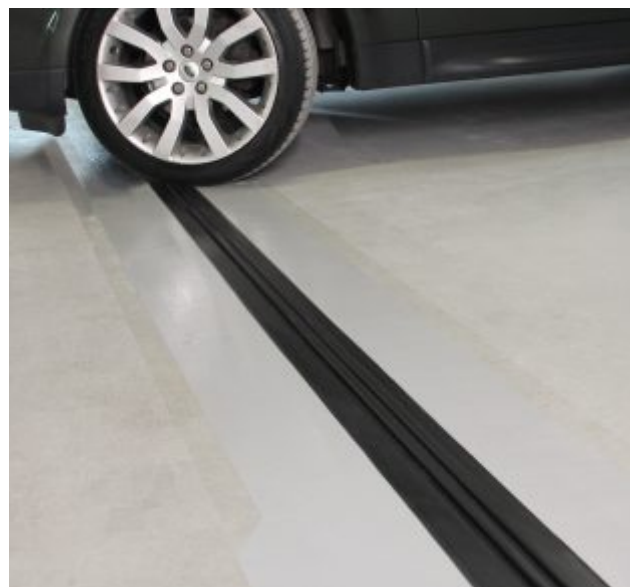

# FloorBridge® CP 20/80

Can be coated

## DESCRIPTION OF THE JOINT PROFILE

The FloorBridge® CP 20/80 joint profile is a pre-fabricated polymer floor joint profile in carbon fibre composite technology with coating flange. The sinus curve of the joint profile allows an optimal load distribution and therefore hardly noticeable vibrations are the result, when trafficked. The joint profile is provided with a recessed coating flange along both sides, so that a watertight coating connection in the transition area is ensured.

## AREA OF APPLICATION

Joint profile for new construction and for the renovation of floor joints in multi-storey and basement car parks, park decks, shopping malls and ramps.

## FEATURES / BENEFITS

- metal-free – therefore cannot corrode
- tight coating connection
- simple installation
- low installation height
- temperature resistant, weatherproof and chloride resistant
- suitable for vehicular traffic
- can be driven on after a few hours

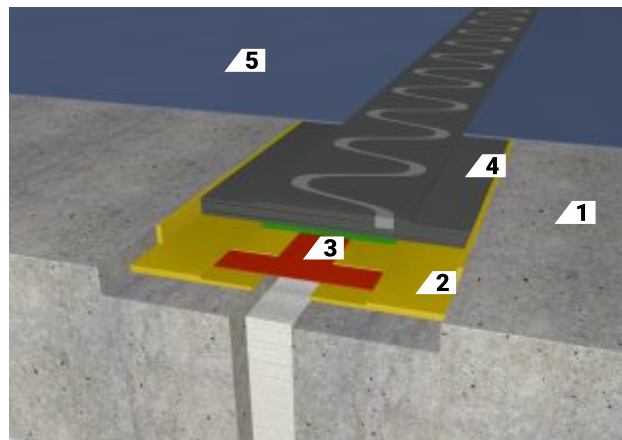
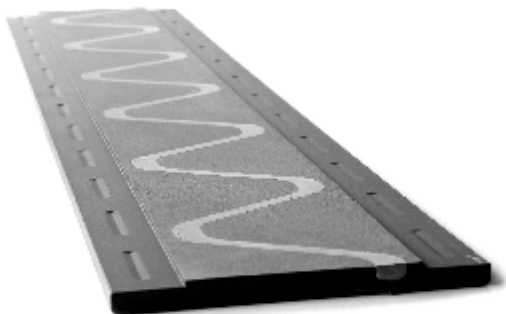

- 1 concrete
- 2 composite adhesive
- 3 sealing tape
- 4 joint profile CP 20/80
- 5 coating

## TECHNICAL DATA

Width of joint profile:	ca. 260 mm
Length of joint profile:	ca. 1200 mm installed (1195 mm net)
Thickness of joint profile:	ca. 20 mm
Joint width in the substrate:	max. 80 mm
Dirt brake (sealant):	ca. 20 mm (depending on version)
Total horizontal joint movement:	50 mm (-10/+40 mm)
Compressive strength:	60 N/mm <sup>2</sup> (ONR 23303)
Bending tensile strength:	50 N/mm <sup>2</sup> (DIN EN 196-1)
Load (Truck):	600 kN (DIN 1072)



# FloorBridge® SL 15/05

For cracks and shrinkage joints

## DESCRIPTION OF THE JOINT PROFILE

The FloorBridge® joint profile SL 15/05 is a pre-fabricated polymer floor joint profile in carbon fiber composite technology without coating flange.

## AREA OF APPLICATION

Joint profile for new construction and for the renovation of floor joints in multi-storey and basement car parks, park decks, shopping malls and ramps.

## FEATURES / BENEFITS

- metal-free – therefore cannot corrode
- simple installation
- low installation height
- temperature resistant, weatherproof and chloride resistant
- suitable for vehicular traffic
- can be driven on after a few hours

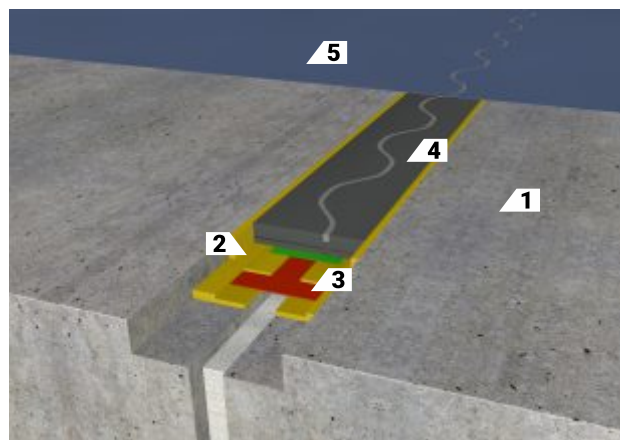

- 1 concrete
- 2 composite adhesive
- 3 sealing tape
- 4 joint profile SL 15/05
- 5 coating

## TECHNICAL DATA

Width of joint profile:	ca. 80 mm
Length of joint profile:	ca. 1200 mm installed (1195 mm net)
Thickness of joint profile:	ca. 15 mm
Joint width in the substrate:	max. 5 mm
Dirt brake:	ca. 5 mm (depending on version)
Total horizontal joint movement:	5 mm (-2/+3 mm)
Compressive strength:	60 N/mm <sup>2</sup> (ONR 23303)
Bending tensile strength:	50 N/mm <sup>2</sup> (DIN EN 196-1)
Load (Truck):	wheel load 5000 kg per 10 cm <sup>2</sup> bearing surface

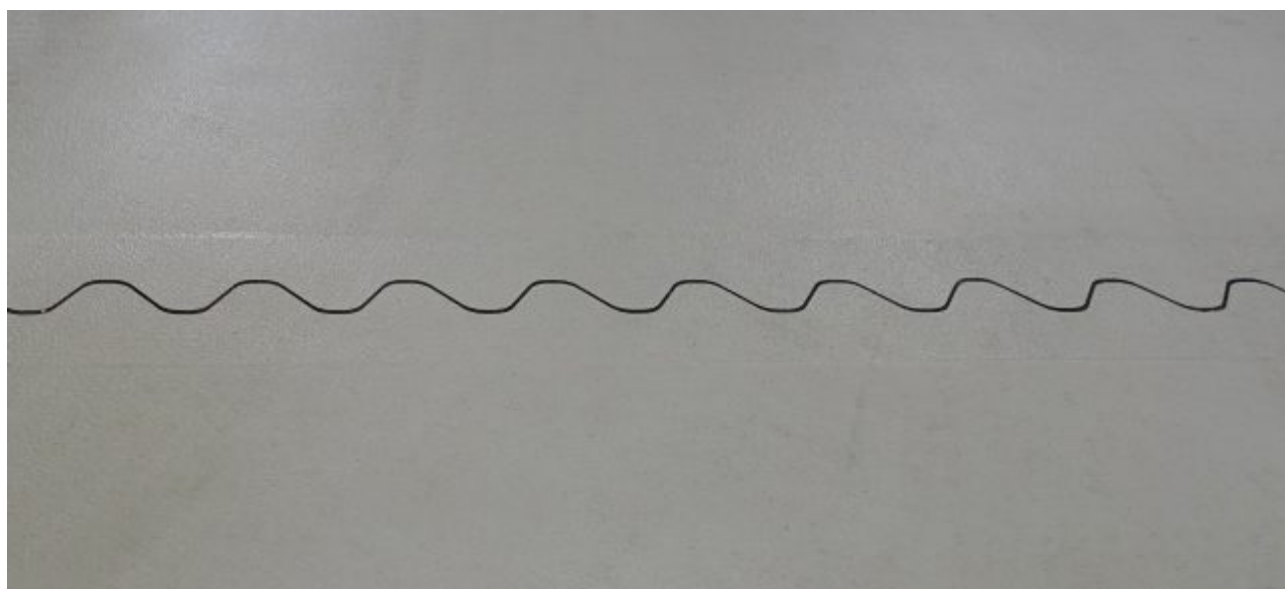



# FloorBridge® CPS SHAPED PARTS

The right detailed solution for all requirements

For intersections, wall connections and other details, there are a variety of **shaped parts** that FloorBridge® offers, depending on requirements.



**CPS L-Shaped part**  
Art. No. 80



**CPS Floor/Wall-Shaped part 90°**  
Art. No. 68



**CPS T-Shaped part**  
Art. No. 81



**CPS Cross-Shaped part**  
Art. No. 79

An individual adjustment of the shaped parts is possible on site.



**CPS Wall connection profile**  
Art. No. 93



FloorBridge® **WALL PANEL** (24 x 20 cm)  
Art. No. WP



# FloorBridge® CP SHAPED PARTS

The right detailed solution for all requirements

For intersections, wall connections and other details, there are a variety of **shaped parts** that FloorBridge® offers, depending on requirements.

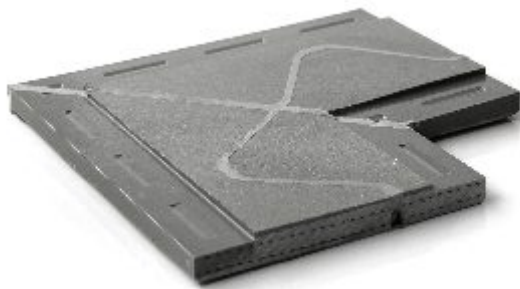

**CP 20/80 L-Shaped part**  
Art. No. 88



**CP 20/80 Floor/Wall-Shaped part 90°**  
Art. No. 90



**CP 20/80 T-Shaped part**  
Art. No. 89



**CP 20/80 Cross-Shaped part**  
Art. No. 87

An individual adjustment of the shaped parts is possible on site.

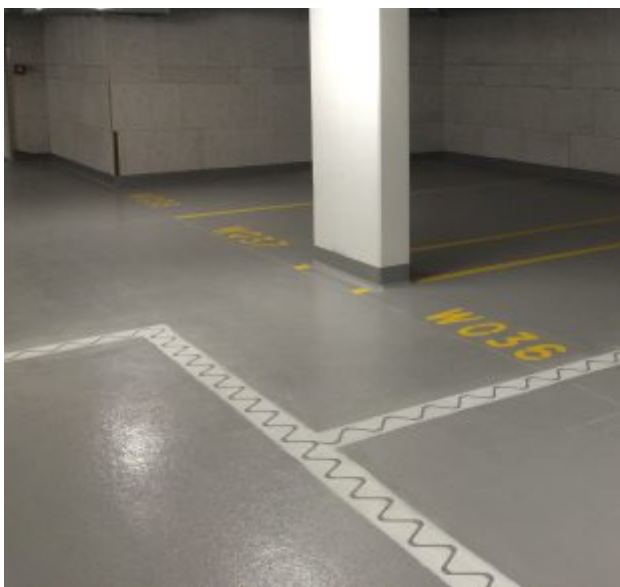

FloorBridge® **WALL PANEL** (24 x 20 cm)  
Art. No. WP

# ACCESSORIES / OTHER PRODUCTS

**Sealing membrane** (20 m rolls) various width...



SM 150/1 mm - Art. No. 33  
SM 200/1 mm - Art. No. 69  
SM 250/2 mm - Art. No. 53

**Sealing membrane for outside corners** 100 x 100 mm  
Art. No. 71

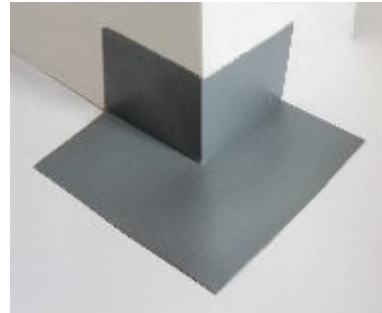

**Sealing membrane for inside corners** 100 x 100 mm  
Art. No. 72



**Rubber insert for CPS 20/50**  
Art. No. 100



**Rubber insert for CPS 20/80**  
Art. No. 101



**Wall connection rubber for CPS-Profile**  
Art. No. 102



**Wall panel** 24 x 120 cm  
Art. No. WP 24x120



**FloorBridge® Adhesive Connect 03**  
9 kg - Art. No. 35  
30 kg - Art. No. 34



**Trowel FloorBridge® SP 04 universal**  
Art. No. 37



**Pressing roller** 50 mm  
Art. No. P1-229/5



# INNOVATIVE SOLUTIONS

The right component for every requirement

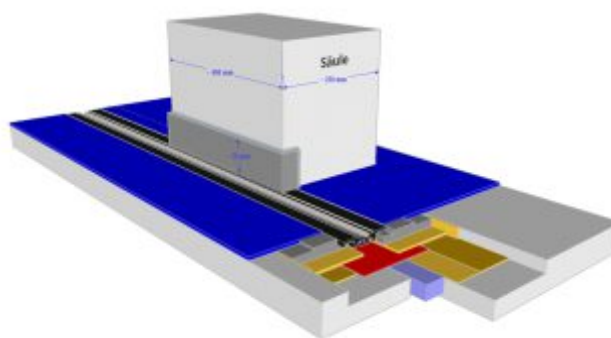
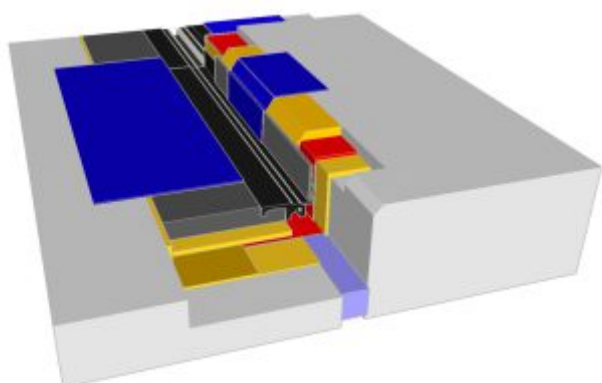
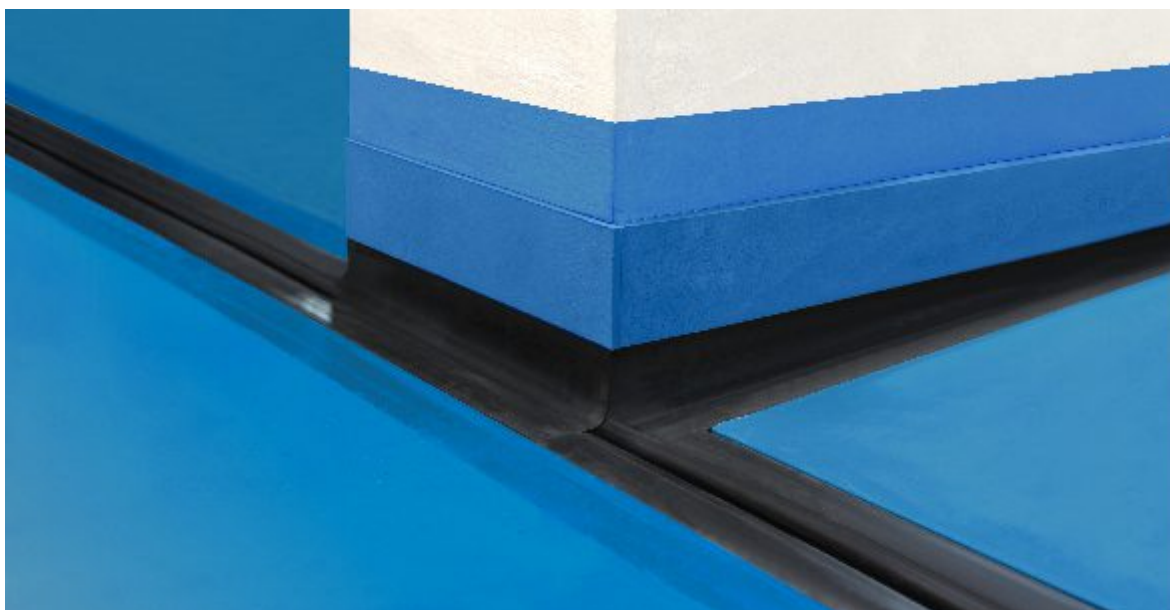





### **HEAD OFFICE / HEADQUARTER**

FloorBridge® International GmbH  
Gewerbepark 21  
4101 Feldkirchen an der Donau  
Österreich / Austria  
T: +43 7233 20 030  
E: [office@floorbridge.com](mailto:office@floorbridge.com)  
W: [www.floorbridge.com](http://www.floorbridge.com)

[www.floorbridge.com](http://www.floorbridge.com)